

升级完成，自动重启系统。



特别说明：

为了保证用户体验，芝杜 Zidoo 会不定期更新固件。因此，本说明书的操作说明，有可能会与产品实际使用情况稍有出入。

Introduction to Hardware of Z10 PRO

Device Interface

zidoo Z10 PRO is equipped with audio and video input & output ports and data transmission ports. Please refer to the descriptions in this manual.

1. Front

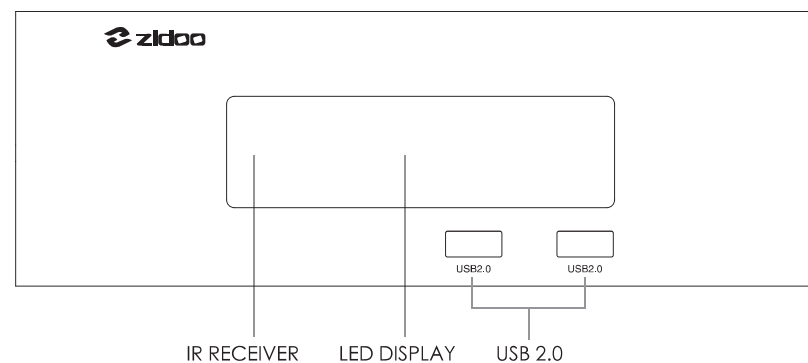

2. Right

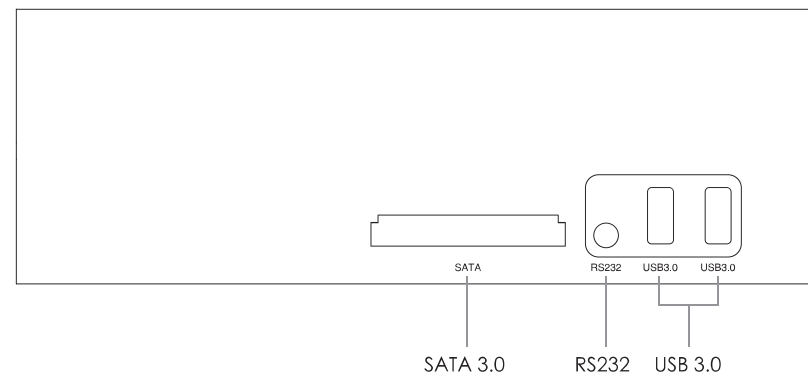

3. Left

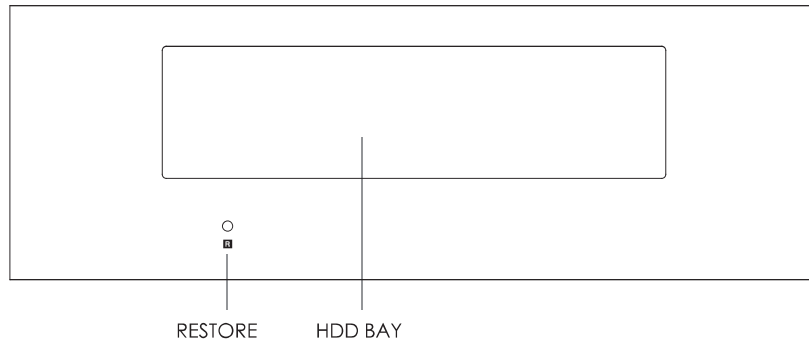

4. Back

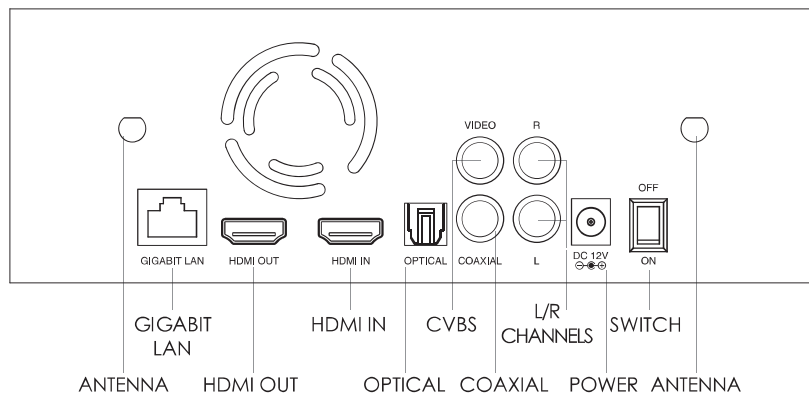

Instruction to installation of the antenna: Please insert the two antennas in the parcel into the antenna ports in the above diagram.

Note:

- *Please load/change the hard disk after turning off the power. If it is a brand-new hard disk, Please load it after formatting it.
- *Please prevent the orifice of the cooling fan from being blocked.
- *Do not touch any liquid in case the liquid runs into the inner part of the device and damage it.
- *Any maintenance personnel who are not appointed are not allowed to open the case.

Load the Hard Disk

Z10 PRO is equipped with 3.5 inches HDD Bay and high speed SATA transmission port. The hard disk can be loaded by pushing with hand. (The maximum hard disk supports 14 TB)

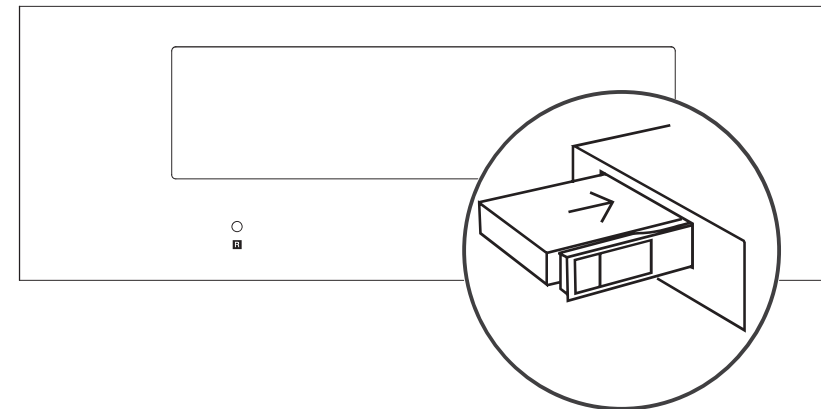

Note: Do not load or change the hard disk while the power is on to avoid damage of the device or hard drive data. If it is a brand-new hard disk, please format it before loading it to the device. This device supports hard disk of the following formats: EXT3, EXT4, NTFS, FAT32, EXFAT.

Device Connection

1. Connect HDMI Cable to TV

1) Cut off the power. Please make sure the power of the TV and STB are off.

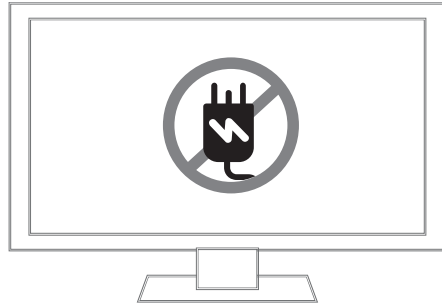

2) When the TV is turned off, please connect HDMI OUT port on Zidoo to HDMI IN port on TV.



3) Connect with the power. This device is equipped with suitable DC power adapter. Please connect the head of DC power adapter to the DC power input port of this device, then insert the plug of DC power adapter into the socket of 110V – 240V.

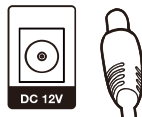

4) Corresponding video source is selected by TV.

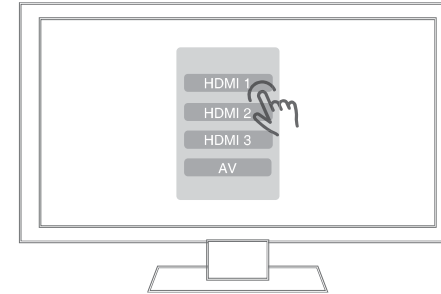

2. Connect AV Cable to the TV

The connection method is same as connecting HDMI cable.

3. Assembly Sequence to Connect RS232 to 3.5mm Connector

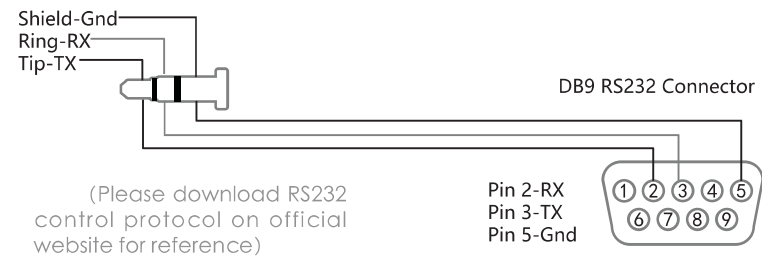

Z10 PRO Specification

Front Display	LED
Shell	Aluminum Alloy
OS	Android 9.0
CPU	Realtek RTD1619 ARM Cortex-A55 (Hexa-core)
GPU	ARM Mali-G51 MP3
Memory	2GB DDR4
Internal Storage	32GB eMMC
WIFI	2.4G + 5G dual-band WiFi, 802.11 a/b/g/n/AC 2T2R MIMO 867Mbps
Ethernet	1*RJ-45 Ethernet Jack (10/100/1000Mbps)
HDMI Out	HDMI 2.0a, support up to 4K @ 60p, HDR, 12Bit, YCbCr 4:4:4 color range, support audio pass-through
HDMI In	HDMI 2.0, support 4K@60p, PCM audio
Video Decoder	4K@60p,HEVC/H.265,12Bit, HDR10, HDR10+, Dolby vision
Audio Decoder	Support high-definition audio pass-through and audio decode
Intelligent Control	Mobile APP control, RS-232, TCP/IP control and WOL support
SATA	1*SATA 3.0, 1*HDD Bay
USB	2*USB 3.0, 2*USB 2.0
Power Supply	DC 12V 2A
Other interface	1*IR Receiver, 1*RCA Cvbs, 1*RCA Audio L/R Channels, 1*Coaxial, 1*SPDIF(2CH, 5.1CH), 1*3.5 (mm) RS232, 2*External High-Gain Antenna

Initialization

Before actually using this device, you will be provided with this software for the first initialization. Please set your device according to the initialization process to obtain the optimum watching experience.

1. System Language

Select the language of the system as you want.



2. Screen Scaling

Adjust the screen display range using LEFT or RIGHT button of the remote control (Mouse Wheel) so that the image can be appropriately displayed on the screen of the TV.

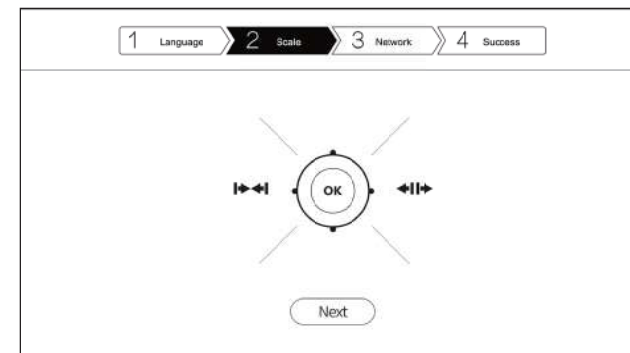

3. Network Setting

Set the configuration of the network so that the device can quickly connect with the network. The network includes WIFI network and Ethernet network. Select either of them and successfully connect with it.

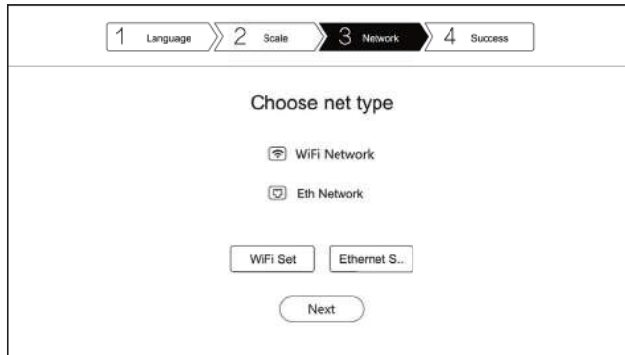

WiFi: Select SSID and enter password, connect to WIFI and finish setting.

Ethernet Network: Insert the network cable and then Internet will be connected automatically. After completing the network setting, it will show "Set success" and enter into Home Page. Initialization setting is finished.

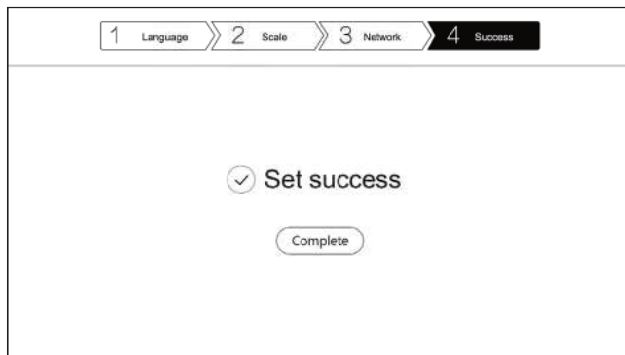

OTA System Update

Zidoo will update the firmware aperiodicity.

Find the update icon in APPs center and click it, online network update and local update are supported. After ticking "Automatically detect the latest version", you will receive the prompt for the latest firmware update automatically.



1. Online Update

Click "Online Update" to obtain information of online update.

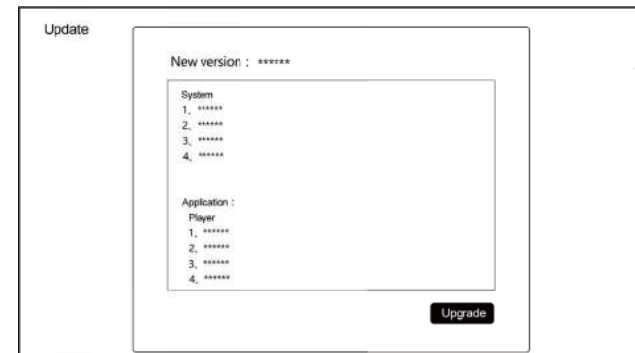

2. Local Update

Users can download the update files on the forum or official website and update firmware through files. Copy the downloaded update file to USB disk. Click "USB update" to select the update file.

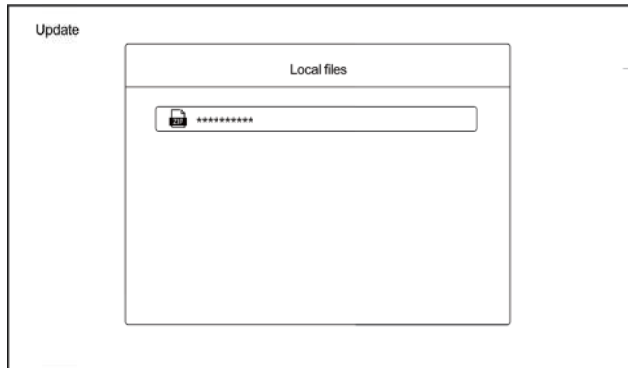

The system will automatically check the update file whether is completed or not.

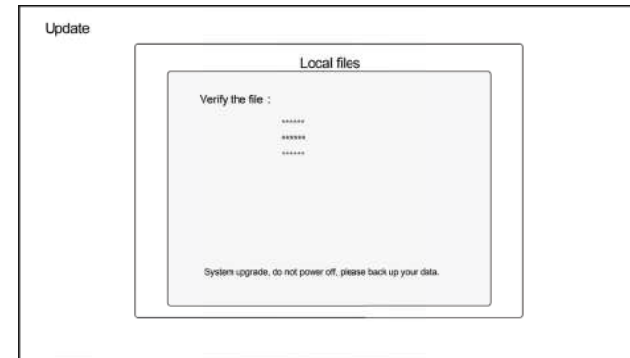

Download the update file by online update or local update. Click "Update" to update it.

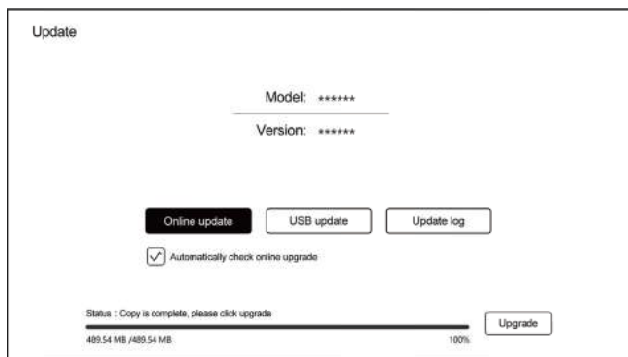

Note: Automatically access to system upgrade. Please don't power off in the progress.

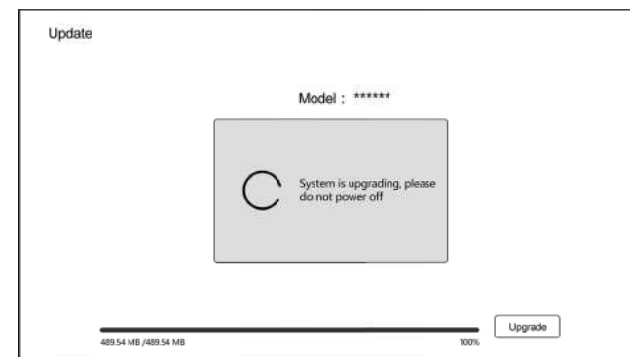

Once the update process is completed, the system will automatically restart.



Special Note:

To guarantee user experience, Zidoo will update the firmware aperiodicity. Therefore, this manual may not be totally in line with the product.

Guarantee 保修卡

User File
用户信息

User name 用户姓名		Sex 性别	
Address 回寄地址			
Telephone 联系电话		Zip 邮编	
Commodity name and specification 产品名称		Model NO. 型号	
Fault description 故障说明			

Guarantee Item
保修条款

- (1) One year guarantee from date of purchased. (not including fittings)
- (2) All of damage by man-made(tear open the housing,tear off the sticker,unnormally using),or losing this card,we will not guarantee.
- (1) 保修期限：本产品遵循国家三包条例，商品存在非人为损坏所引起的硬件故障，本公司将提供一年保修服务（配件除外）。
- (2) 如需寄回本公司维修，请与此保修卡一同寄回。
- (3) 一切人为因素造成的损坏（包括擅自拆机，撕毁标签，自行刷机等等），本公司将不予保修。





QUALIFIED
CERTIFICATE
合格证

CHECKER/检验员 _____

DATE/日期 _____

